

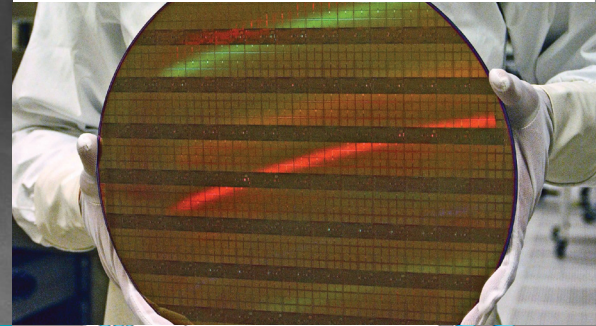

FURON[®]
Pure Performance



Furon[®] A2 Dampener

High-Purity Fluoropolymer Bellow, Air Operated Dampener

Furon A2 Dampeners are specifically designed to be used with Furon A2 Pumps and are constructed with no metal parts. All wetted parts are manufactured from high-purity PFA and PTFE and are suitable for dampening aggressive chemicals or slurries. The dampener reduces pump pulsation up to 85% of their nominal value and directly adapt to the pump stroke and line pressure. This eliminates the need for a costly and complicated 3rd-party component, making installations a very simple process.

Applications

The Furon A2 Dampener, coupled with a Furon A2 Pump, offers the perfect solution for superior performance and a reduced cost of ownership for transfer, recirculation, dispensing and bulk delivery for semiconductor, photovoltaic and chemical processing industries, or any industry where high-purity and chemical resistance is a must.

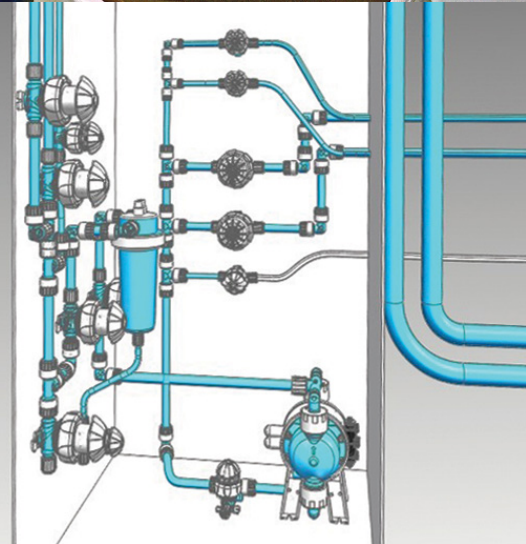

Features and Benefits

- Metal free dampener
- HP PFA/PTFE flow path
- O-ring free flow path concept (tongue & groove concept)
- Flexible connection system compatible with all fitting types

ASK AN ENGINEER



SAINT-GOBAIN

Ordering Information

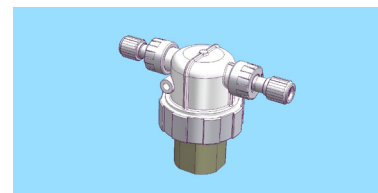
Part Number	Media	Recommended Pump Size	End Connection Orientation	End Connection Type	End Connection Size			
					in	mm		
A2MC1 1F8	Chemical	1;2	Straight / Straight	Compatible Flare	1/2	12.7		
A2MC1 1T8				Tube End				
A2MC2 1F12		2;3		Straight / Straight	Compatible Flare	3/4	19.05	
A2MC2 1T12					Tube End			
A2MC3 1F16		3		Straight / Straight	Compatible Flare	1	25.4	
A2MC3 1T16					Tube End			
A2MC1 2F8		1;2	Straight / Elbow	Compatible Flare	1/2	12.7		
A2MC1 2T8				Tube End				
A2MC2 2F12		2;3		Straight / Elbow	Compatible Flare	3/4	19.05	
A2MC2 2T12					Tube End			
A2MC3 2F16		3		Straight / Elbow	Compatible Flare	1	25.4	
A2MC3 2T16					Tube End			
A2MC1 3F8		1;2	Elbow / Elbow	Compatible Flare	1/2	12.7		
A2MC1 3T8				Tube End				
A2MC2 3F12		2;3		Elbow / Elbow	Compatible Flare	3/4	19.05	
A2MC2 3T12					Tube End			
A2MC3 3F16		3		Elbow / Elbow	Compatible Flare	1	25.4	
A2MC3 3T16					Tube End			
A2MS1 1F8		Slurry	1;2	Straight / Straight	Compatible Flare	1/2	12.7	
A2MS1 1T8					Tube End			
A2MS2 1F12			2;3		Straight / Straight	Compatible Flare	3/4	19.05
A2MS2 1T12						Tube End		
A2MS3 1F16			3		Straight / Straight	Compatible Flare	1	25.4
A2MS3 1T16						Tube End		
A2MS1 2F8			1;2	Straight / Elbow	Compatible Flare	1/2	12.7	
A2MS1 2T8					Tube End			
A2MS2 2F12			2;3		Straight / Elbow	Compatible Flare	3/4	19.05
A2MS2 2T12						Tube End		
A2MS3 2F16			3		Straight / Elbow	Compatible Flare	1	25.4
A2MS3 2T16						Tube End		
A2MS1 3F8	1;2		Elbow / Elbow	Compatible Flare	1/2	12.7		
A2MS1 3T8				Tube End				
A2MS2 3F12	2;3			Elbow / Elbow	Compatible Flare	3/4	19.05	
A2MS2 3T12					Tube End			
A2MS3 3F16	3			Elbow / Elbow	Compatible Flare	1	25.4	
A2MS3 3T16					Tube End			

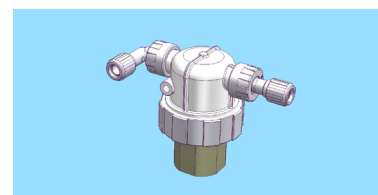

End Connection
Straight / Straight



End Connection
Elbow / Straight

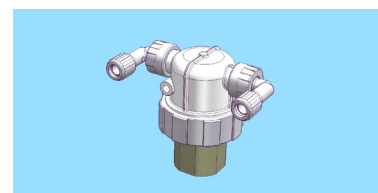

End Connection
Elbow / Elbow

PM Kit

Dampener Type	PM Part Number
A2MC1 XXXX	PM A2MC1
A2MC2 XXXX	PM A2MC2
A2MC3 XXXX	PM A2MC3
A2MS1 XXXX	PM A2MS1
A2MS2 XXXX	PM A2MS2
A2MS3 XXXX	PM A2MS3

Ordering & Technical Specifications

Max. Liquid Pressure	80 PSIG (5.5 bar)	
Maximum Air Pressure	87 PSIG (6 bar)	
Operating Temperature	Ambient:	140°F (60°C)
	Media Range*:	35°F to 185°F (0°C to 85°C)

* [Contact Us](#) for higher-temperature version.

Dimensions

A2MS1 and A2MC1

Connection Type	Dimensions											
	A		B		C		D		E (radius)		F	
	mm	inch	mm	inch	mm	inch	mm	inch	mm	inch	mm	inch
F8	277.2	10.91	130.3	5.13	146.8	5.78	116.9	4.6	80.5	3.17	239	9.41
T8	277.8	10.94	114.8	4.52	163	6.42	104.2	4.10	85.9	3.38	244.4	9.62

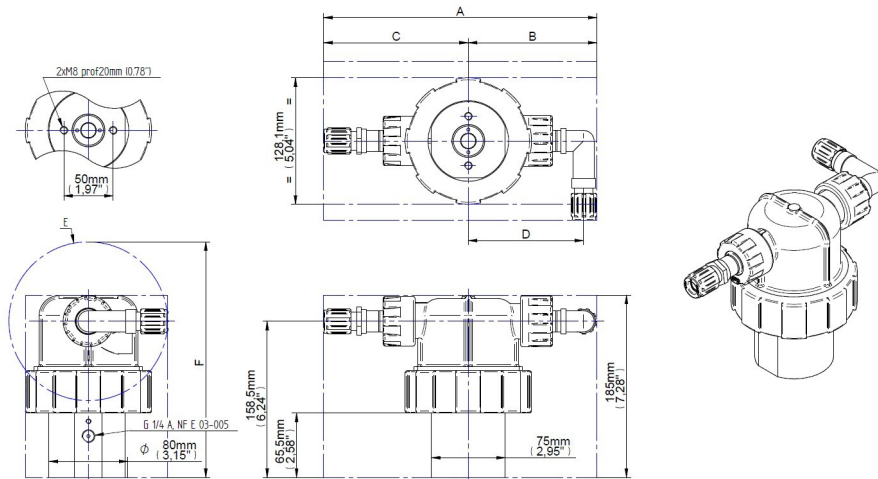

A2MS2 and A2MC2

Connection Type	Dimensions											
	A		B		C		D		E (radius)		F	
	mm	inch	mm	inch	mm	inch	mm	inch	mm	inch	mm	inch
F12	263.7	10.38	120.9	4.76	142.8	5.62	104.2	4.10	77.4	3.05	235.9	9.29
T12	277.8	10.94	114.8	4.52	163	6.42	104.2	4.10	85.9	3.38	244.4	9.62

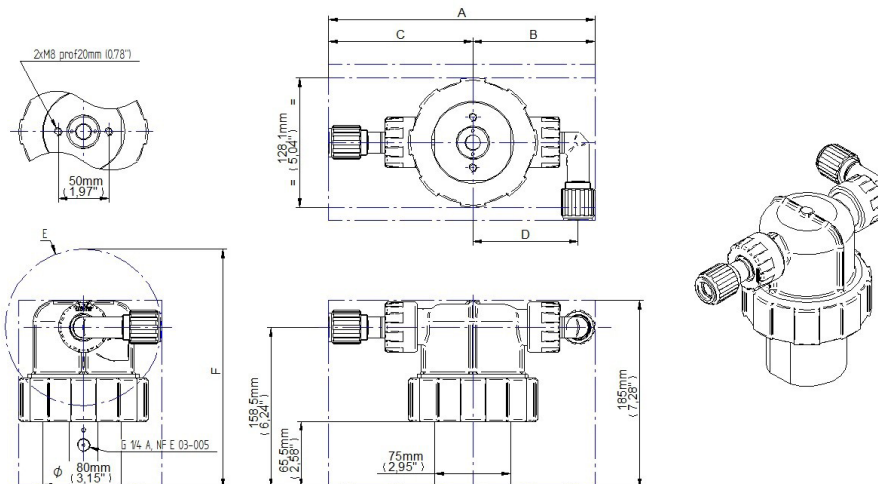

Dimensions

A2MS3 and A2MC3

Connection Type	Dimensions											
	A		B		C		D		E (radius)		F	
	mm	inch	mm	inch	mm	inch	mm	inch	mm	inch	mm	inch
F16	346.6	13.65	167.2	6.58	179.5	7.07	142.4	5.61	78.5	3.09	267.5	10.53
T16	361.2	14.22	155.6	6.13	205.5	8.09	142.4	5.61	103.3	4.07	292.3	11.51

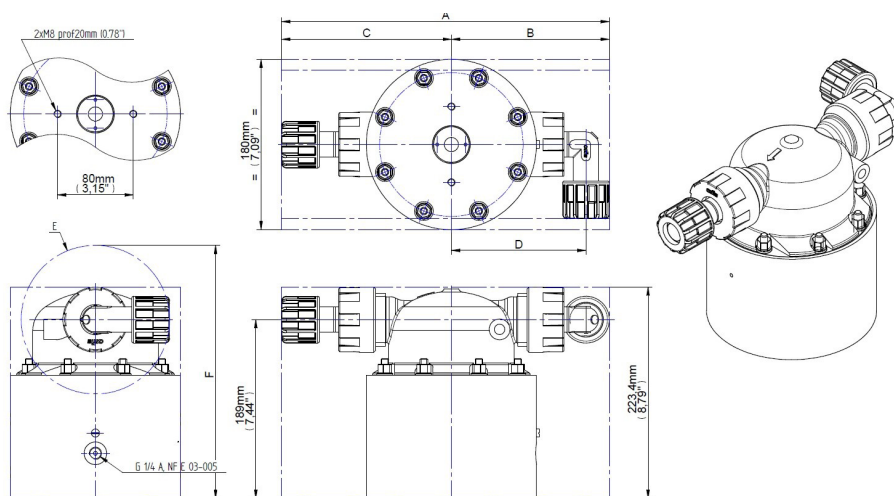

Saint-Gobain Performance Plastics

China (+8621) 5472 1568
Sales.PPLCN@saint-gobain.com

Europe (+33) 3 85 20 27 00
quotes-clm@saint-gobain.com

India (+91) 80 46978888
pplindia.hc@saint-gobain.com

Japan (+81) 3 6256 9703
ls-japan@saint-gobain.com

Korea (+82) 2 6098 0180
LS-Korea@saint-gobain.com

Southeast Asia (+66) 38 667 800
cs.sgplsea@saint-gobain.com

Taiwan (+886) 2 2503 4201
Taiwan.ppl@saint-gobain.com

United States (+1) 800-833-5661
gardengrovequoteteam@saint-gobain.com

All Other Regions
www.furon.com

NOTE: This document is intended to provide information about the product to enable you to consider whether generally the Product meets your application need and is not intended to provide product specification. This document should not be considered a Product warranty or guaranty. To the extent this document mentions any tests done by Saint-Gobain, such tests are done under controlled laboratory circumstances and hence other factors in your use and application may impact such values. Saint-Gobain strongly recommends that you conduct practical tests simulating the conditions of your application to ensure that the product meets your requirements for your specific application.

Furon®, FlareGrip® II and Grab Seal™ are registered trademarks of Saint-Gobain Performance Plastics. Nippon Pillar Super 300® is a registered trademark of Nippon Pillar Packing Co.

WARRANTY: Saint-Gobain warrants that the Product will meet specifications at the time of delivery and honor such warranty claims for a period of 18 or 30 months after delivery, based on configuration. In the event that you are a distributor purchasing Saint-Gobain Product, any change to specification while in your control as a result of storage conditions or otherwise may cause the above warranty to be voided. THIS IS THE EXCLUSIVE WARRANTY AND IS EXPRESSLY IN LIEU OF ANY AND ALL OTHER OBLIGATIONS, GUARANTEES, WARRANTIES AND REPRESENTATIONS. SAINT-GOBAIN DISCLAIMS ALL IMPLIED WARRANTIES OF MERCHANTABILITY AND FITNESS FOR A PARTICULAR PURPOSE.